

GE 7 230/CEE
110/CEE

ETL-Nr. 458.740 Blatt 1
Stand 11/19

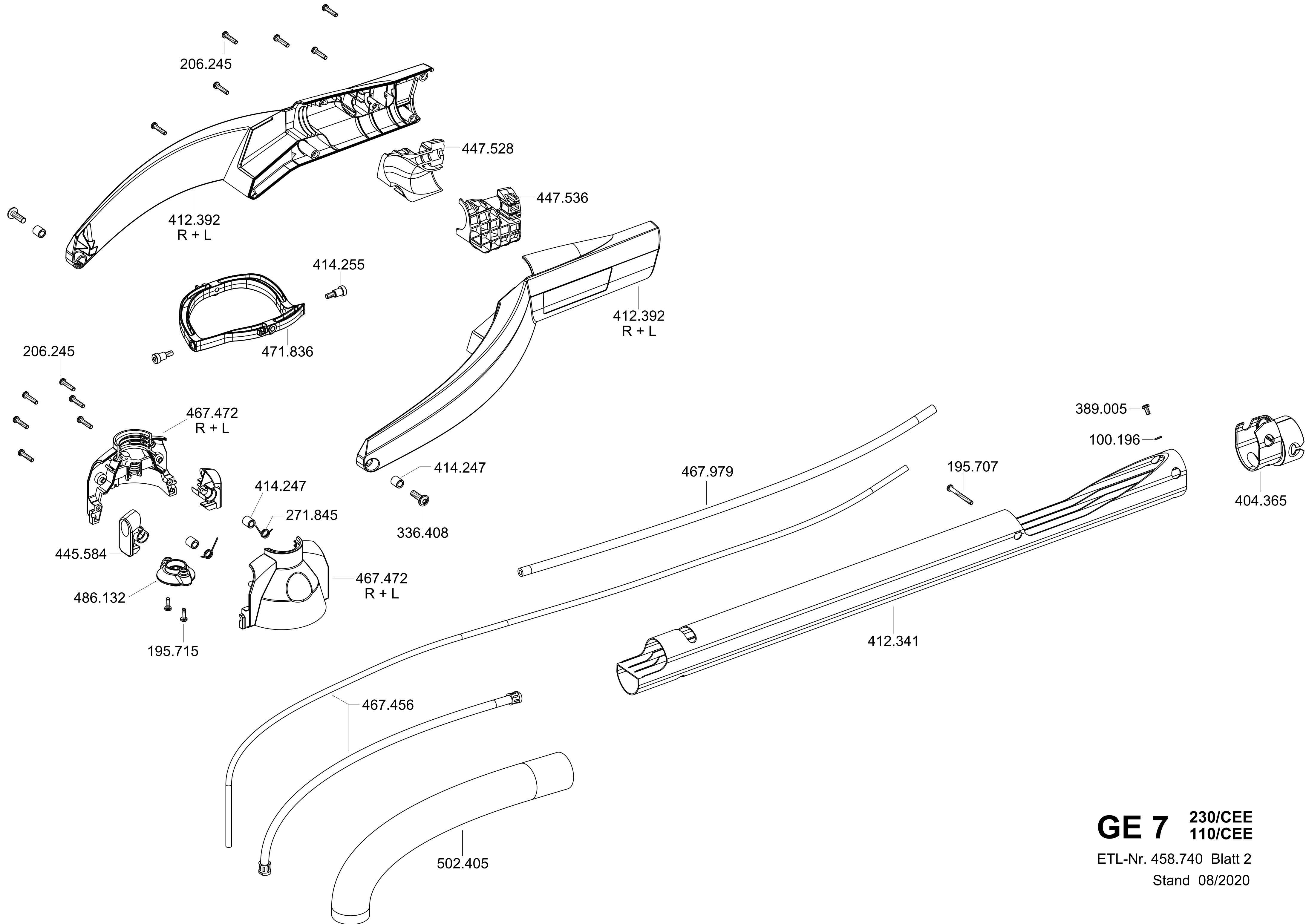

GE 7 230/CEE
110/CEE

ETL-Nr. 458.740 Blatt 2

Stand 08/2020

MH-R D225

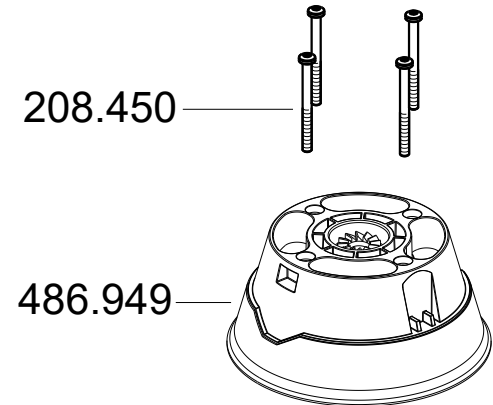
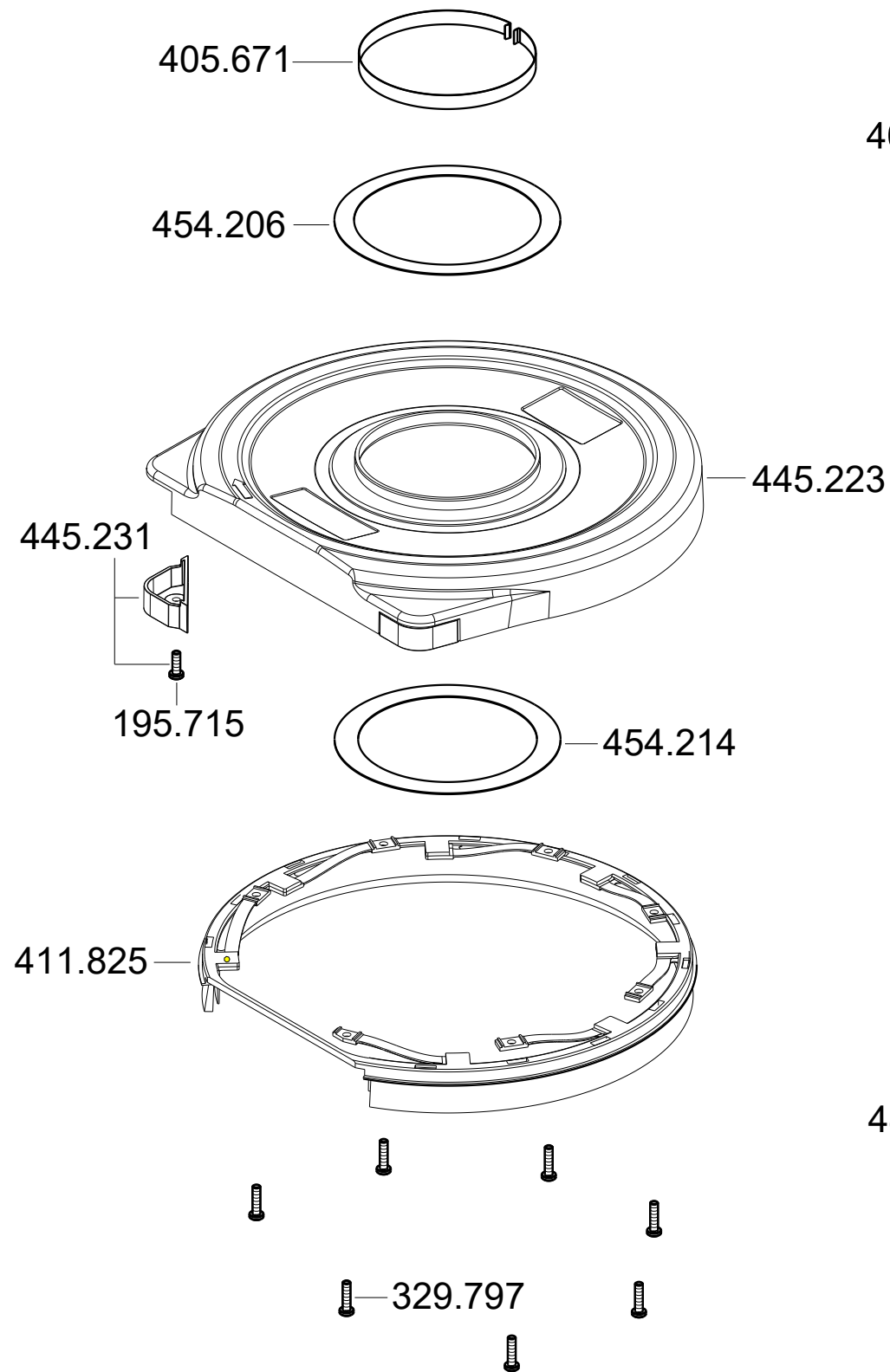

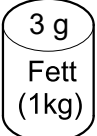
402.648  3 g
Fett
(1kg)
Planeten-
Getriebe

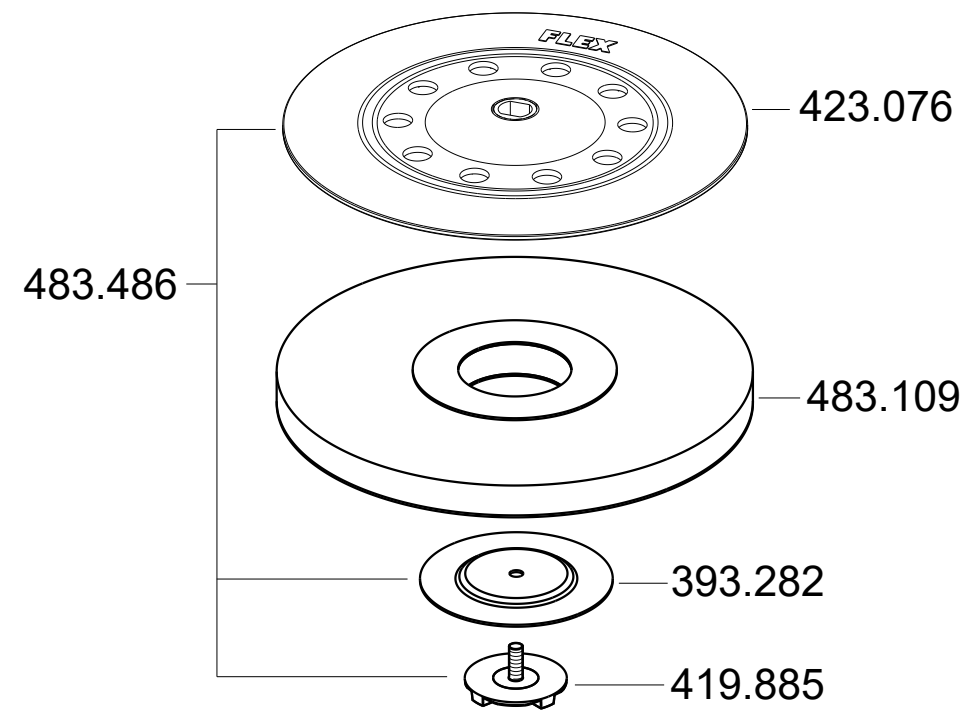
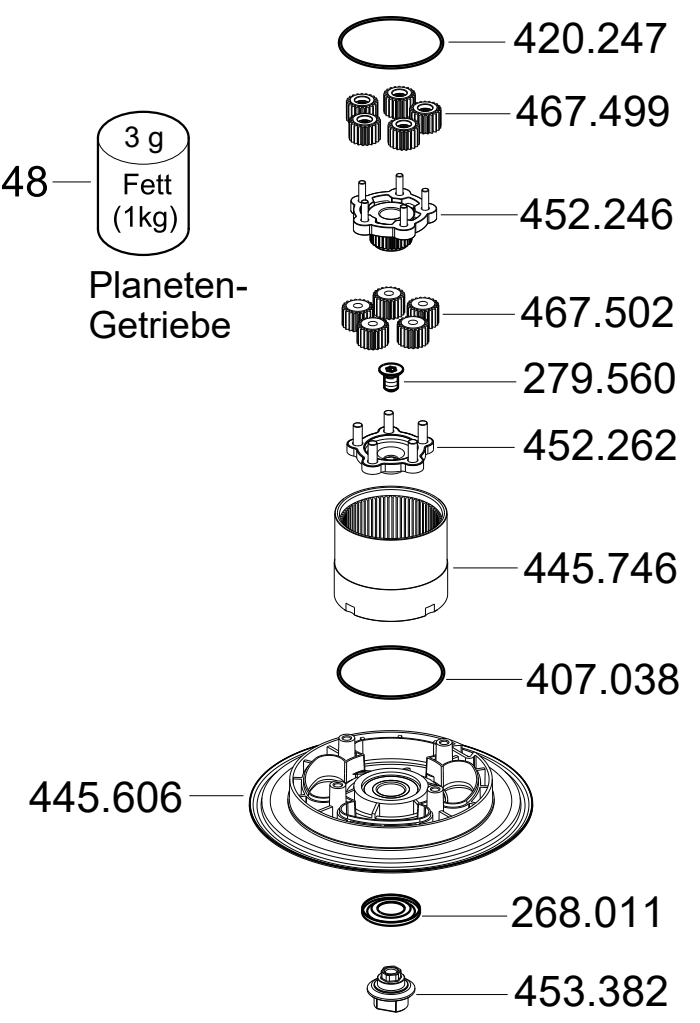

MH-O D225

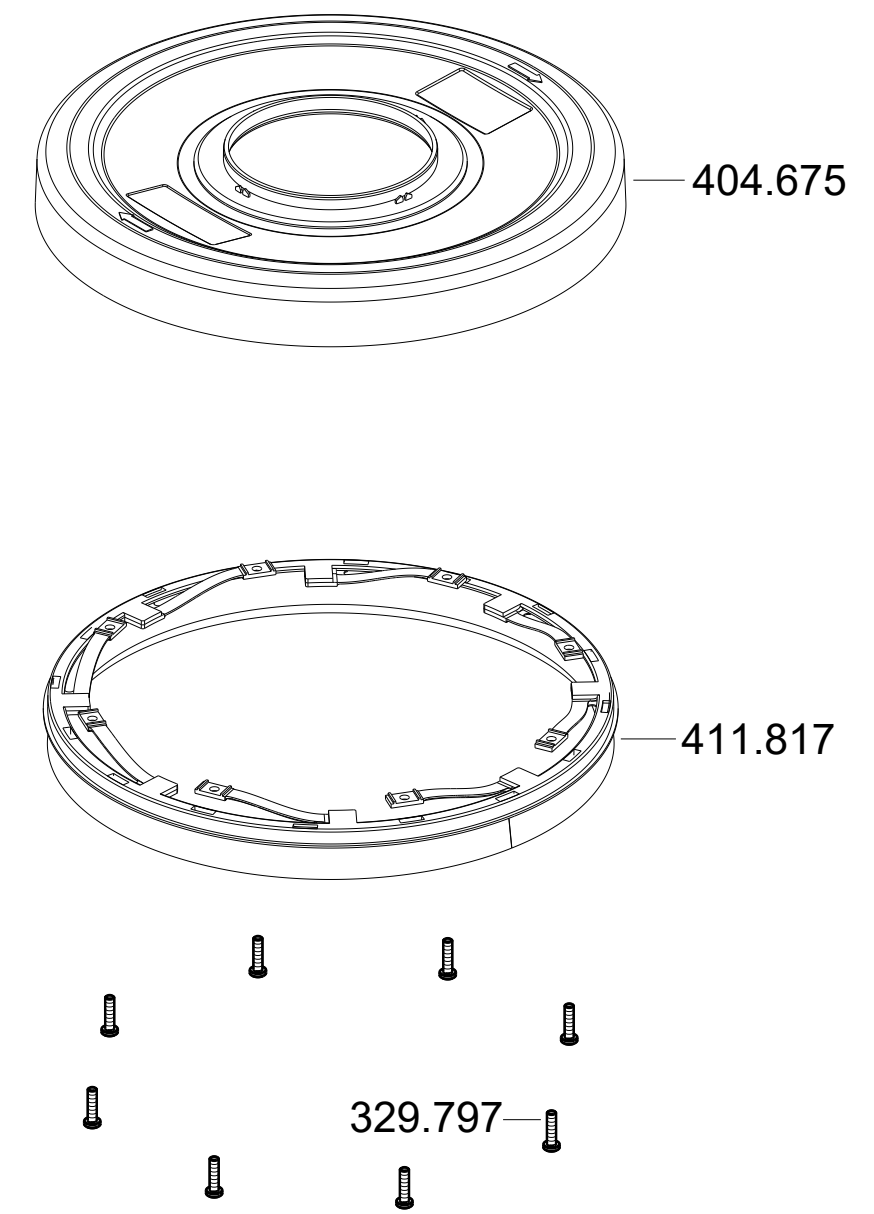

GE 7 230/CEE
110/CEE
ETL-Nr. 458.740 Blatt 3
Stand 02/20

MH-T 290x290

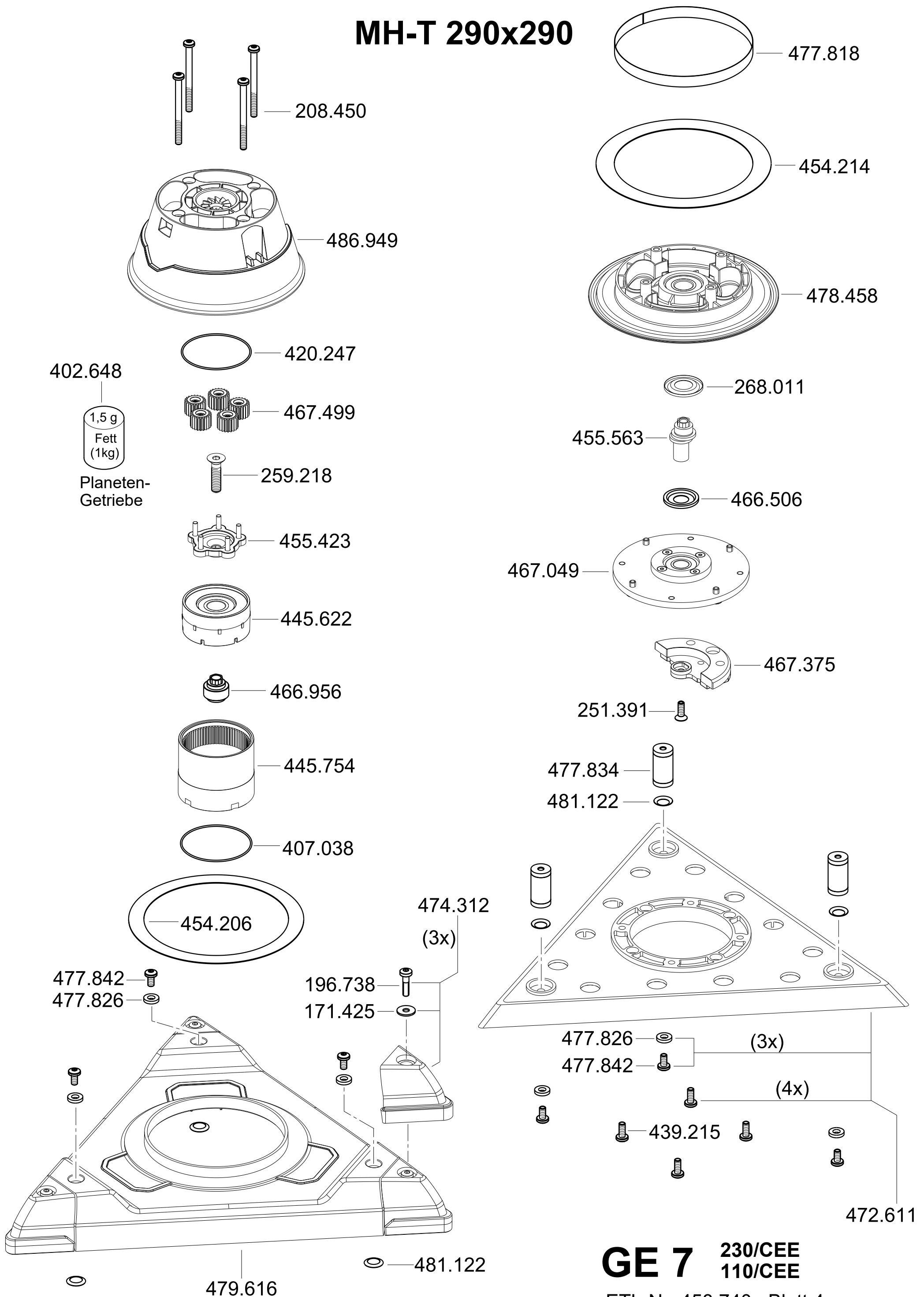

GE 7 230/CEE
110/CEE

ETL-Nr. 458.740 Blatt 4
Stand 11/19

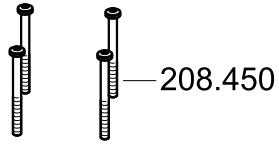

208.450

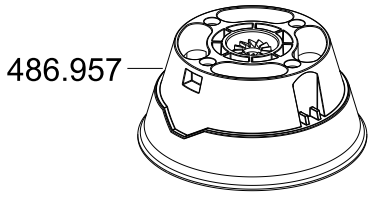

486.957

MH-X D225

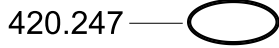

420.247

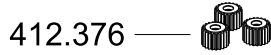

412.376

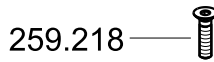

259.218

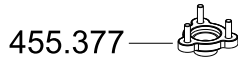

455.377

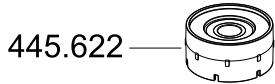

445.622

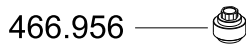

466.956

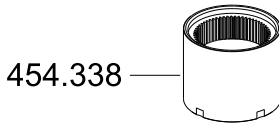

454.338

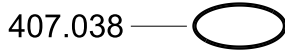

407.038

402.648

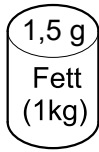

Planeten-
Getriebe

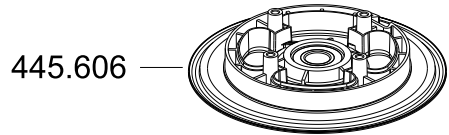

445.606

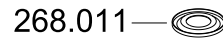

268.011

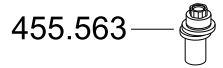

455.563

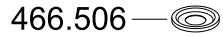

466.506

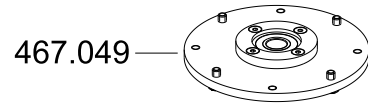

467.049

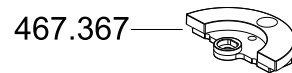

467.367

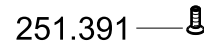

251.391

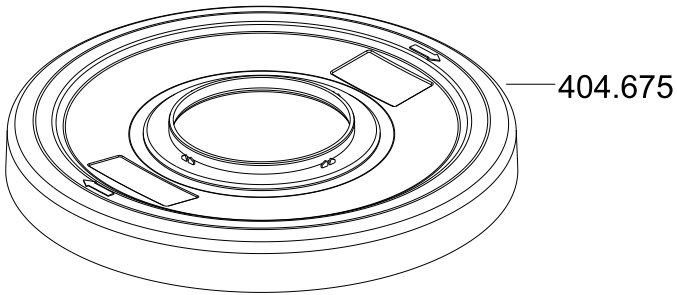

404.675

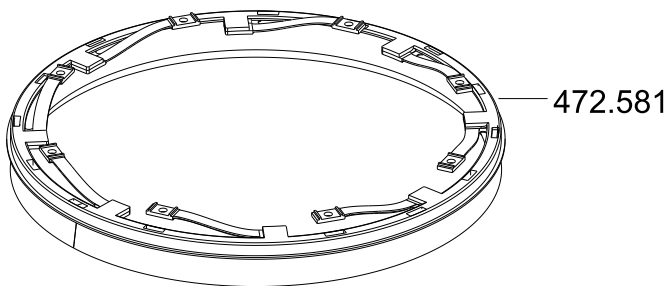

472.581

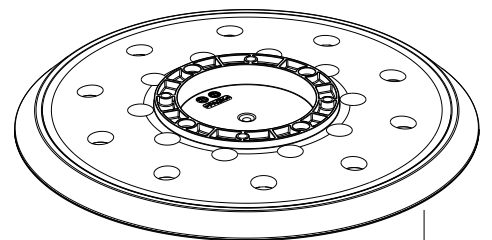

472.603

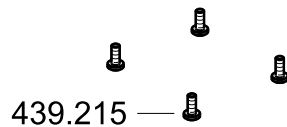

439.215

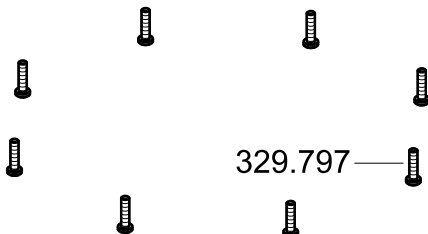

329.797

GE 7 230/CEE 110/CEE

ETL-Nr. 458.740 Blatt 5
Stand 11/19