

VCE 33 L MC

Teile-Nr. 451.177 - Blatt 1
Stand 03/17

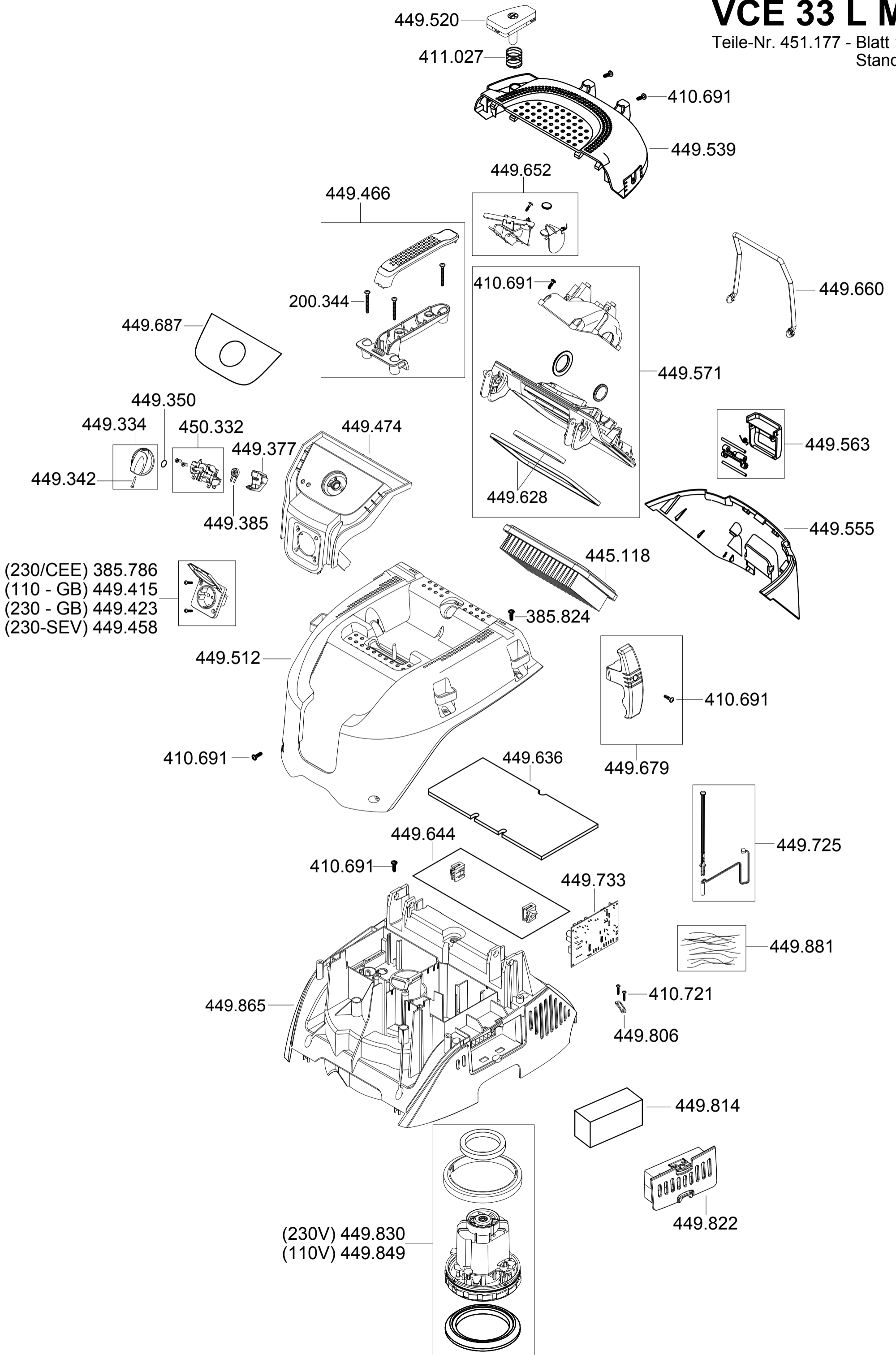

VCE 33 / 44 L AC S 44 L AC

Teile-Nr. 451.177 - Blatt 2
Stand 06/18

(230V-Ausf. 24V) 449.695
(110V-Ausf. 12V) 449.709

449.598 (230V)
449.601 (110V)

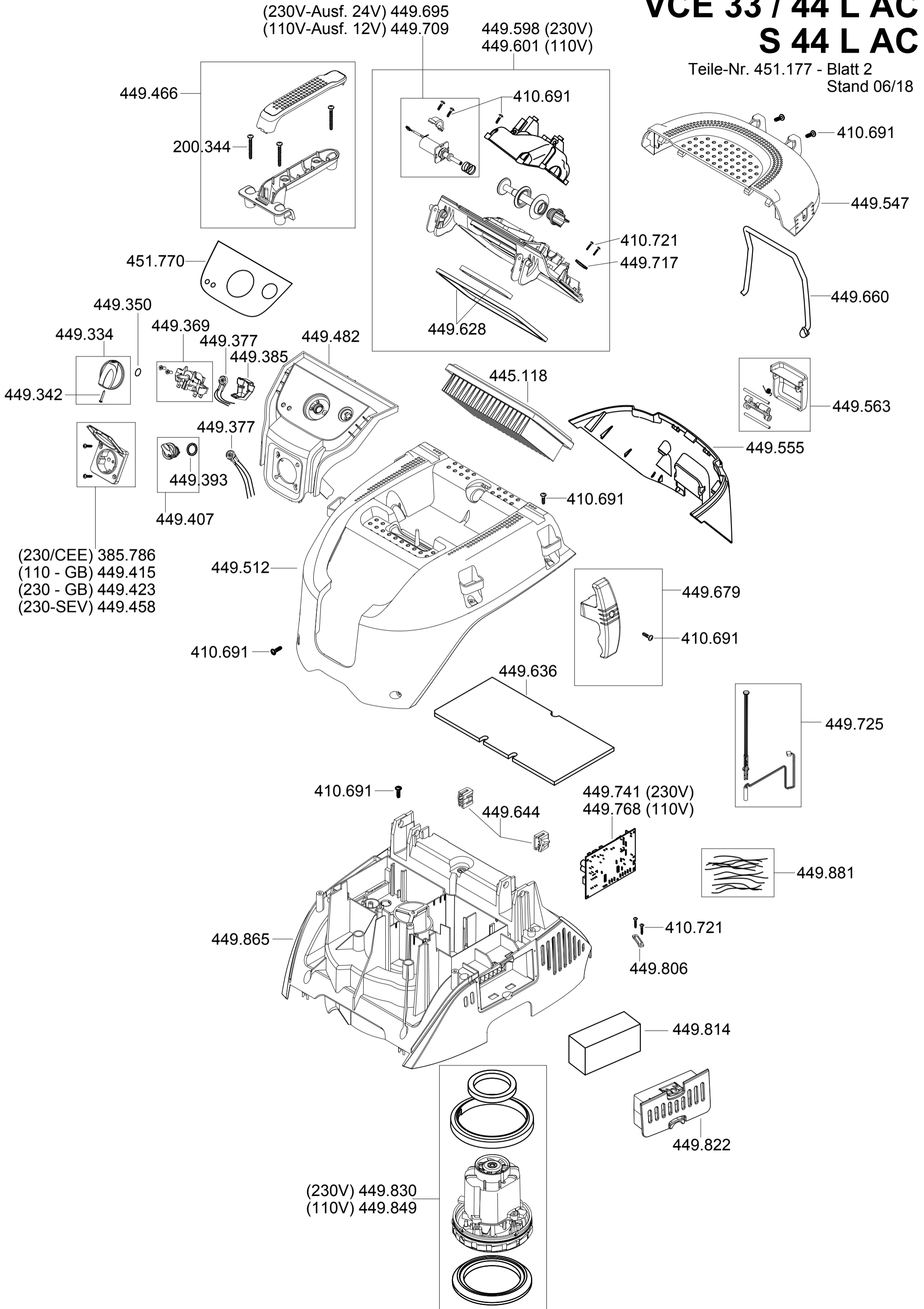

VCE 33 / 44 M AC VCE 44 H AC

Teile-Nr. 451.177 - Blatt 3
Stand 06/18

(230V-Ausf. 24V) 449.695
(110V-Ausf. 12V) 449.709

449.598 (230V)
449.601 (110V)

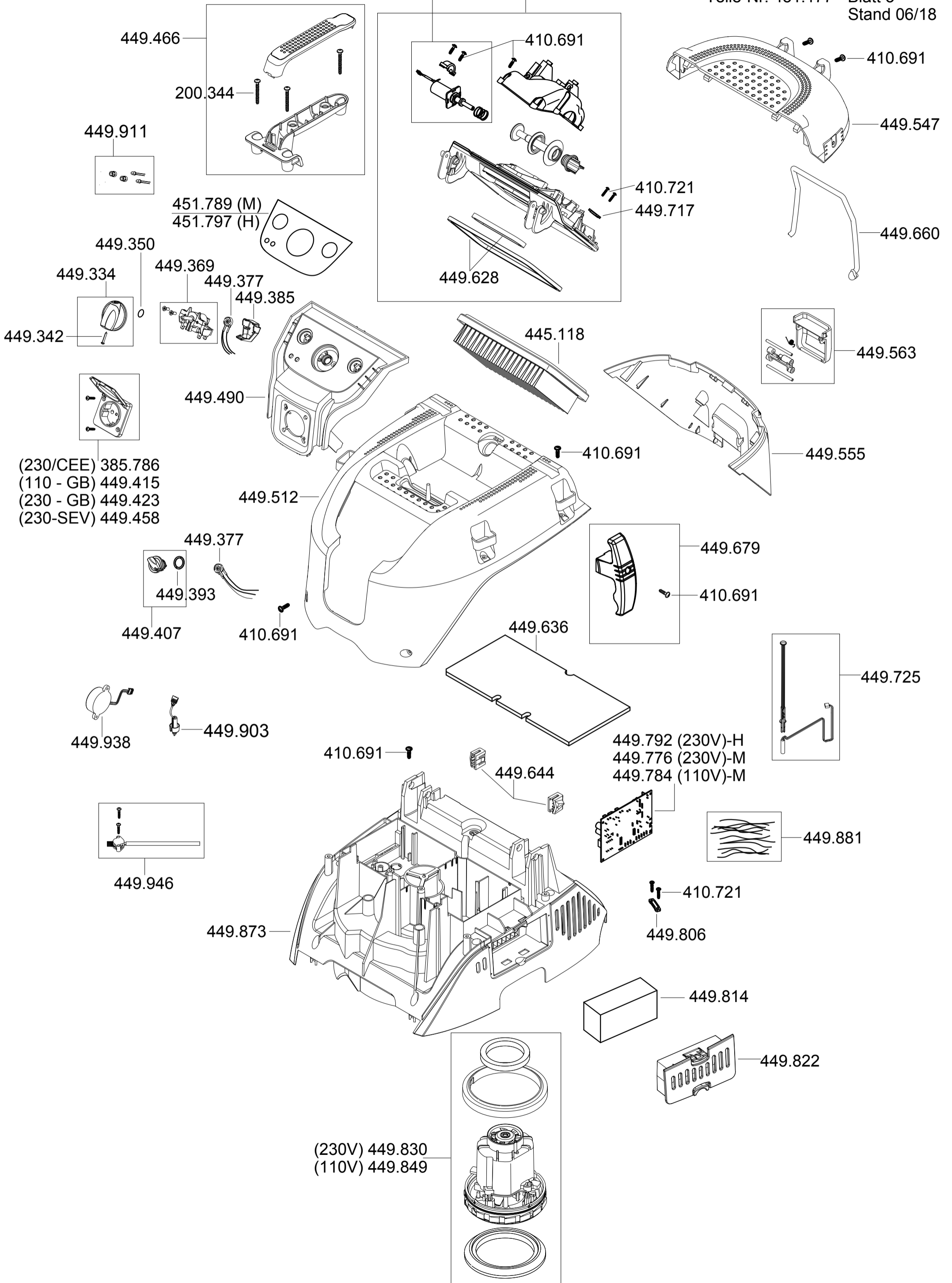

VCE 33

Teile-Nr. 451.177 - Blatt 4
Stand 05/17

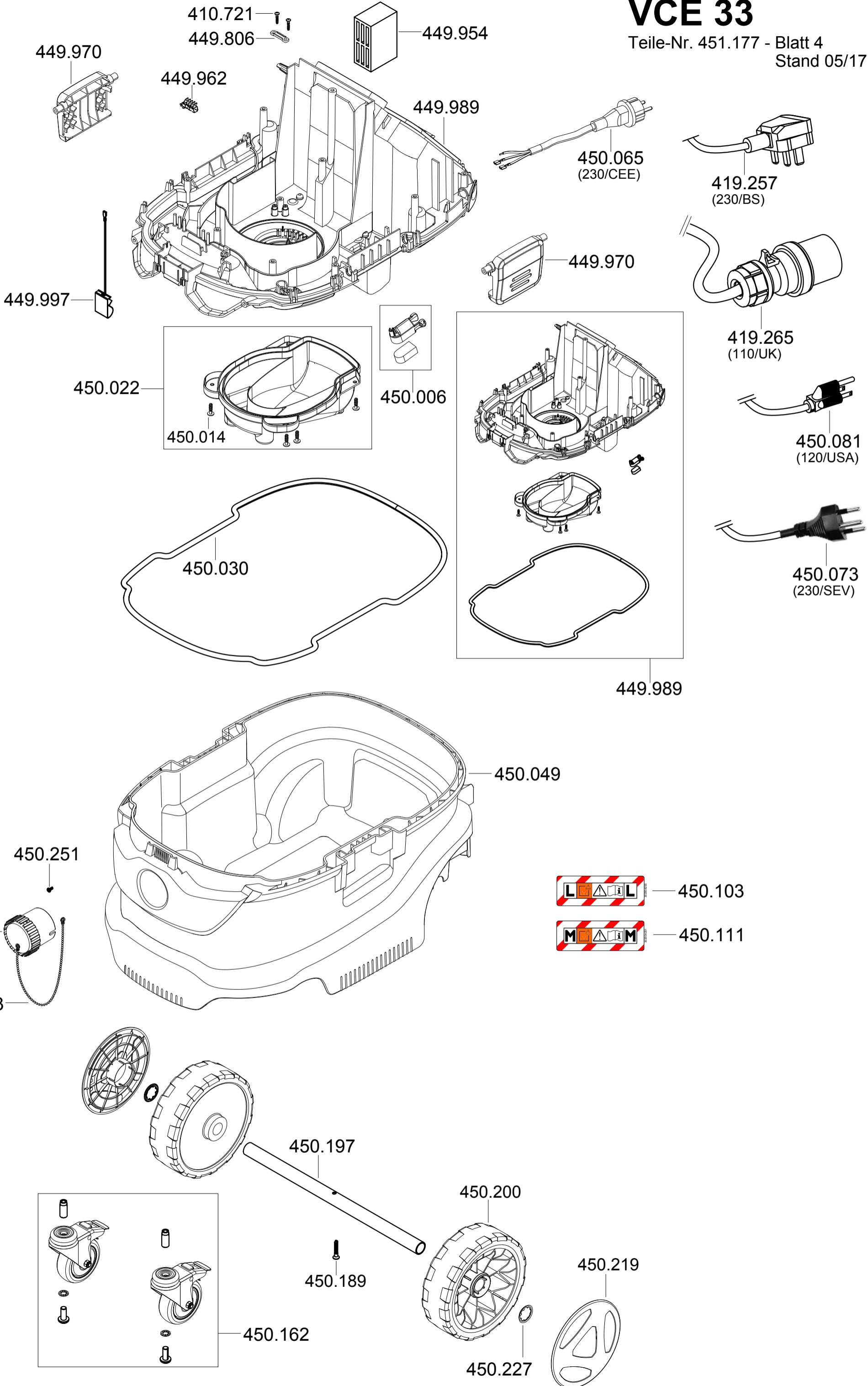

VCE 44 L / M S 44 L

Teile-Nr. 451.177 - Blatt 5
Stand 05/17

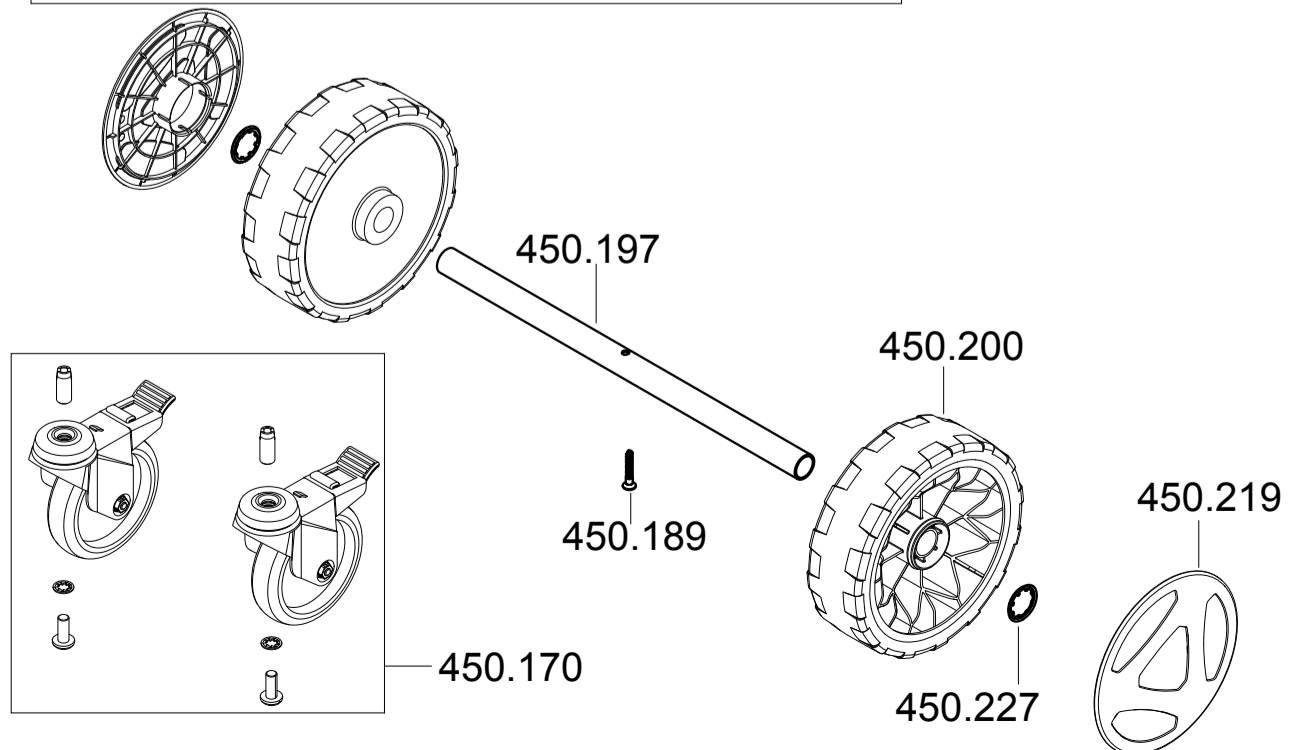
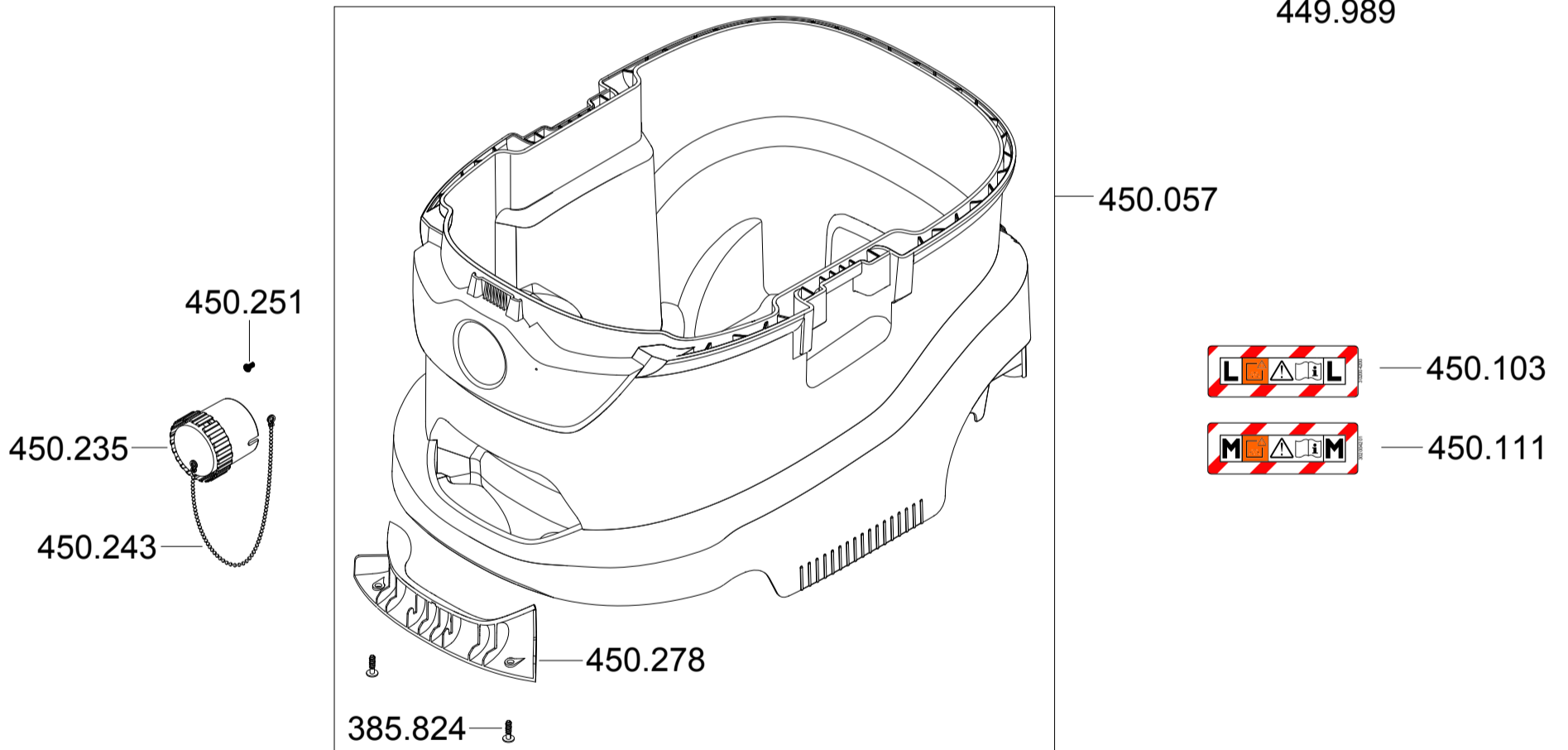
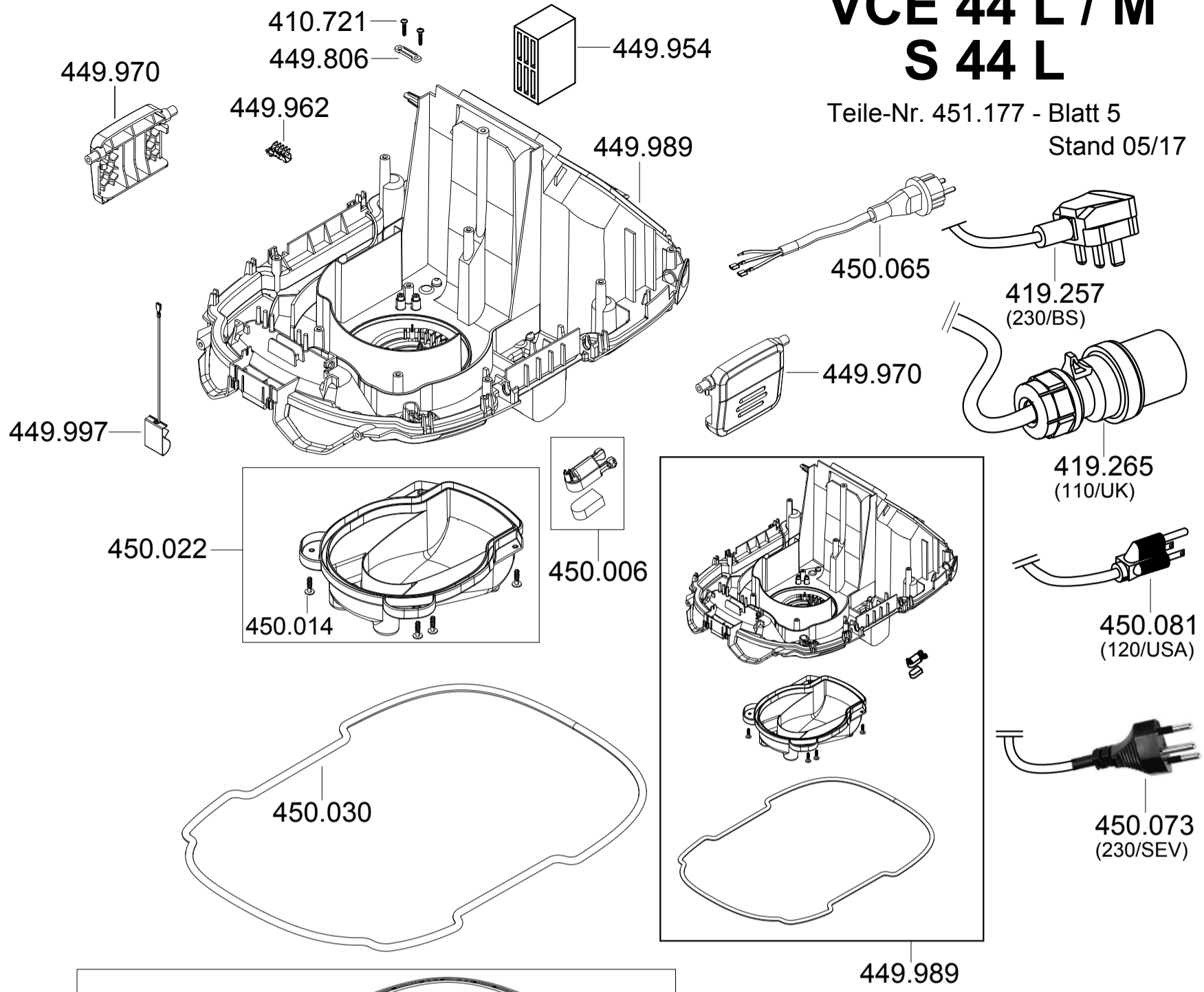

VCE 44 H AC

Teile-Nr. 451.177 - Blatt 6
Stand 09/17

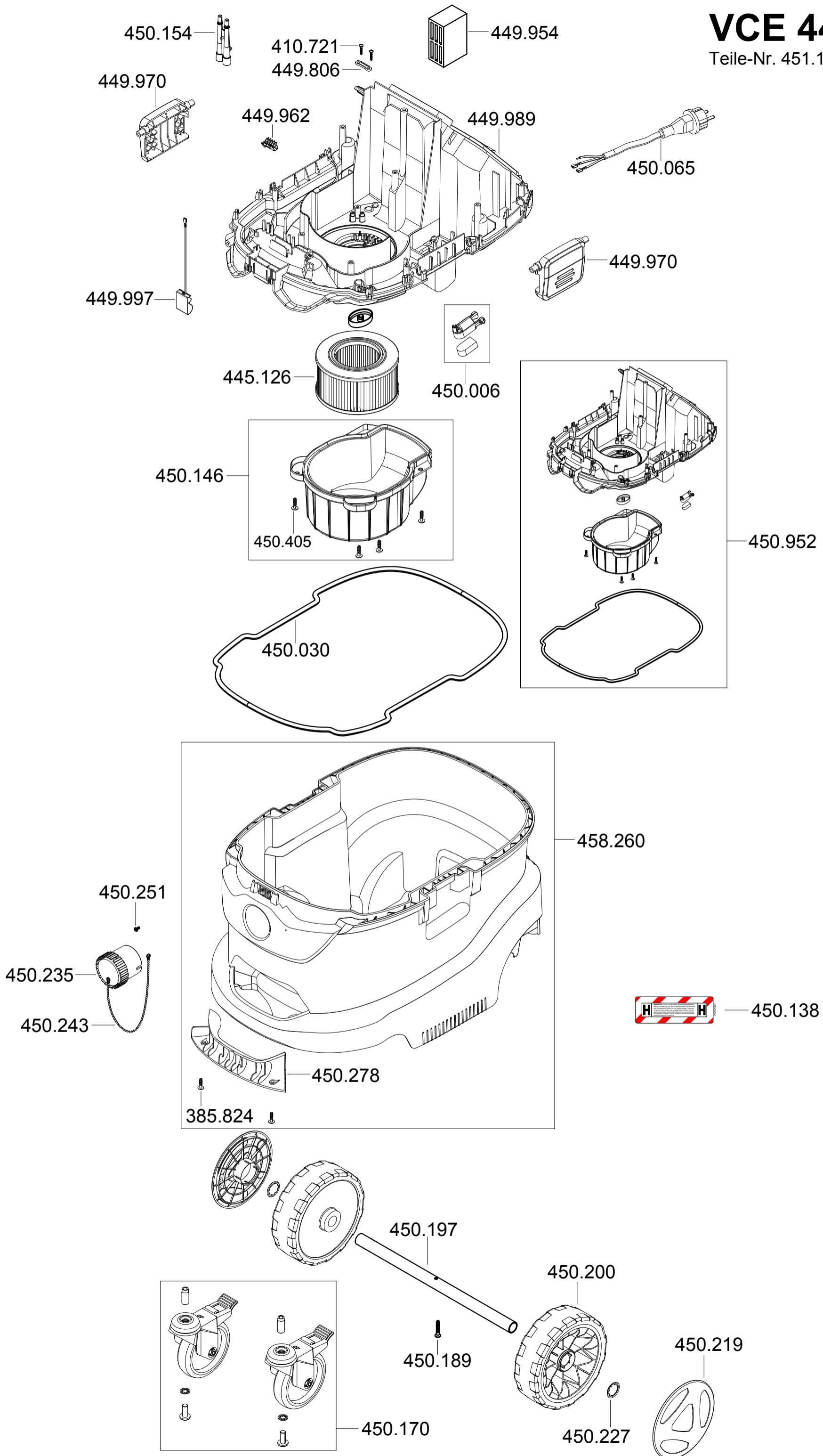

VCE 33 / 44 S 44

Teile-Nr. 451.177 - Blatt 7
Stand 02/19

